

# IEC 61850 engineering StreamDesign

...is the engineering and data management tool that complies with standard IEC 61850. StreamDesign shortens engineering times and improves the quality of results.



### StreamDesign technologies

Designed for Microsoft Windows® operating systems, StreamDesign benefits from all the advantages of a widely used, high performance software.

StreamDesign is accessible via Internet Explorer

Based on standard IEC 61850

### Characteristics

- Compliance with standard IEC 61850 and developed in conformity with the latter
- Ensures user independence in relation to the usual IED suppliers
- Handles projects comprising IEDs from one or more different suppliers

**StreamDesign is the software module of the StreamX product which handles IEC 61850 compliant engineering functions for substations. This complete product gives the user control over all stages of implementation based on standard IEC 61850: from the single line diagram to pre-configuration of IEDs via data management and documentation.**



**IEC 61850**

IEC 61850 is set to become the world standard for substation engineering and communication, whether for transmission or distribution. Supported by SCL language and based on an object-oriented data model, IEC 61850 integrates command control and protection functions specific to the environment of substations. Communication is assured by high performance and secure means.

IEC 61850 defines classes of tools which play different roles in the engineering process. IED configuration tools are proprietary to suppliers. They are used to configure IED functions and load the configuration in IEDs.

Specification tools enable a functional specification of the system to be acquired. This specification is formally defined in an SSD file (System Specification Description).

Based on this specification, the system integration tool enables the IEC 61850 station to be configured in terms of functions and communication. The result of this engineering phase is the SCD file.

**StreamDesign functions**

StreamDesign combines the functions of specification and integration tools. StreamDesign also performs advanced documentation functions.

**Engineering process**

StreamDesign offers great flexibility in how it proposes different engineering phases and is therefore able to support engineering processes for new stations, retrofit, maintenance, and even reverse engineering of an existing station in order to document it and facilitate maintenance.

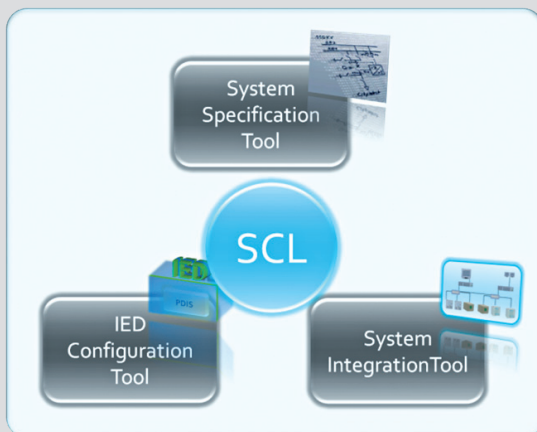

- Bottom Up Engineering** • Start implementation with IEDs
- Top Down Engineering** • Use a formal specification process
- Maintenance** • Fix bugs and make minor enhancements
- Retrofit** • Replace parts or entire system

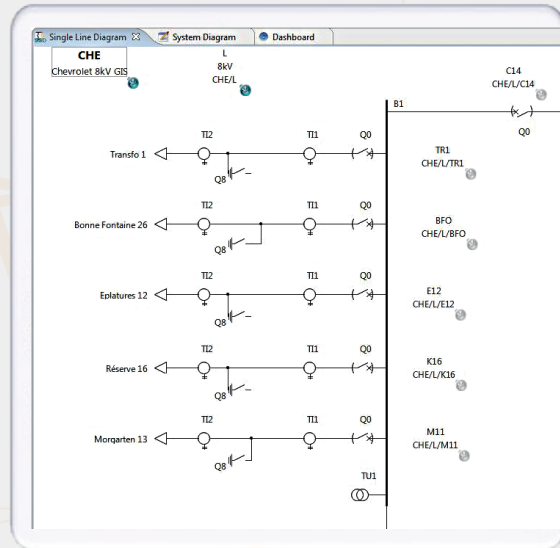

### Specification

The different functions are configured from the single line diagram via logical nodes. Information flows are defined by reports and GOOSE (Generic Object Oriented Substation Event) messages.

At the base of the single line diagram the user can define control and protection functions independently from IEDs used later in the integration phase.

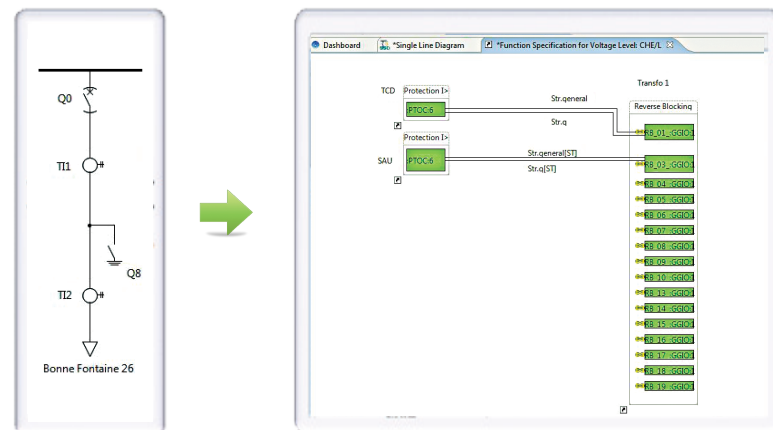

With notions like types, models and libraries, the user can create his own templates allowing time savings when working on similar equipment and on projects for substations with similar configurations.

### Integration

StreamDesign allows definition, backup and presentation of the database containing :

- Configurations of protection and field command and control equipment, except for parameters specific to protection data which remain configured by the proprietary tools of IED suppliers
- The IEC 61850 communication network diagram
- All local command and control data
- Communication data
- All data to be loaded into the control centre

The user's task is greatly facilitated by graphic tools which enable work to proceed at a less abstract level of detail than lists of signals, the latter being generated automatically in SCL language by the StreamDesign tool.

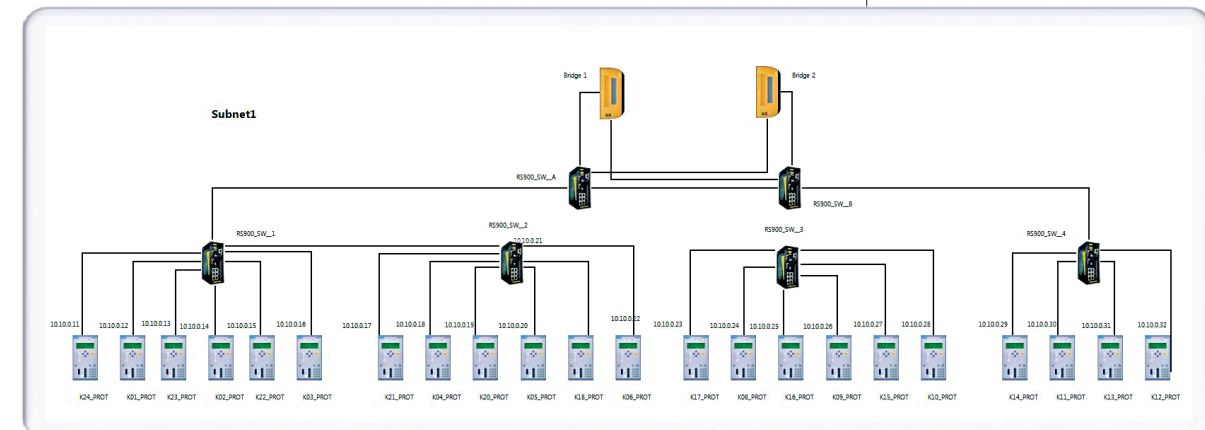

Use of the IED manufacturer's proprietary software is necessary only to create a file to be loaded in StreamDesign which defines the type of hardware used, to complete this file with the protection function settings and finally to transfer the final configuration file to the IED.



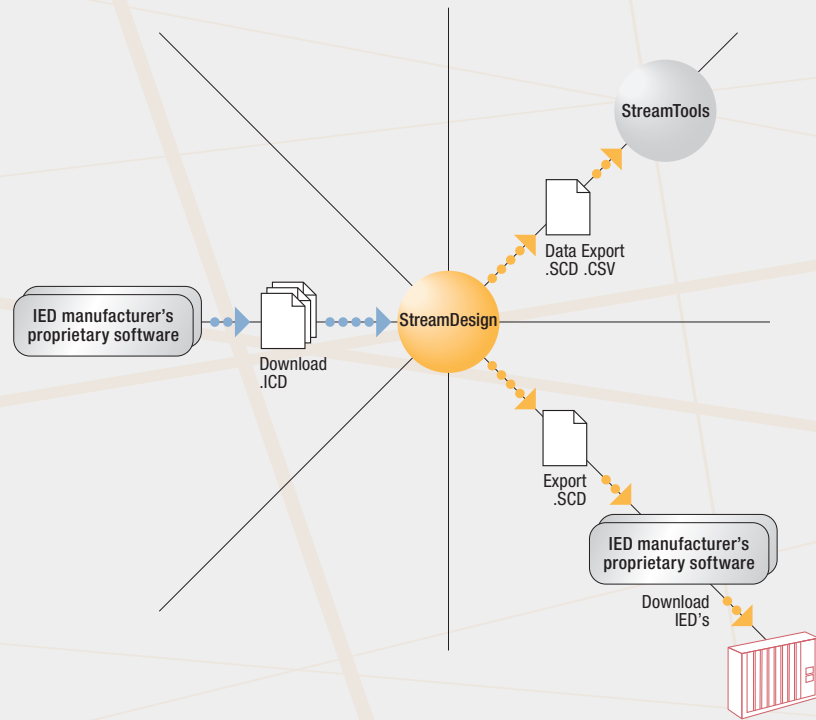

**Documentation**

StreamDesign makes it possible to create complete documentation for each IEC 61850 engineering project. StreamDesign facilitates documentation and reduces the time needed for its preparation. It is created and updated while engineering, production, testing and modification work is in progress.

The documentation offers in particular:

- Single line diagrams for each station and voltage level
  - IEC 61850 communication network diagram
  - File(s) of SCD parameters for IEDs
- Data file of information transmitted to SCADA
  - Test documents

**Maintenance and evolution of installations**

For routine operation and maintenance or modification work, the StreamDesign user benefits from a tool which allows simple and rapid correction, modification and extension of a IEC 61850 installation, while ensuring that only the necessary modifications are made and with the major advantage of having complete documentation to hand.

**Control and independence**

Because StreamDesign is capable of managing all data, either independently of proprietary products or in addition to them, it enables single or multi-manufacturer installations to be produced. For the proprietor-builder-operator of electrical networks, internal use of StreamDesign offers better control of engineering phases, facilitates the acquisition of internal competences and gives greater freedom of implementation than is possible with traditional IED suppliers.

**Complementarity with StreamX**

Integrated in the StreamX solution, StreamDesign offers in addition to the above advantages an interface with StreamTools which considerably reduces the processing time of signals intended for the StreamBridge communication gateway and/or the SCADA StreamBrain computer of a local command and control system. Manual operations are reduced to a minimum to avoid all risk of error and facilitate the user's task.

StreamX with StreamDesign is a complete tool for handling substation projects, from equipment configuration to local or remote control and command.

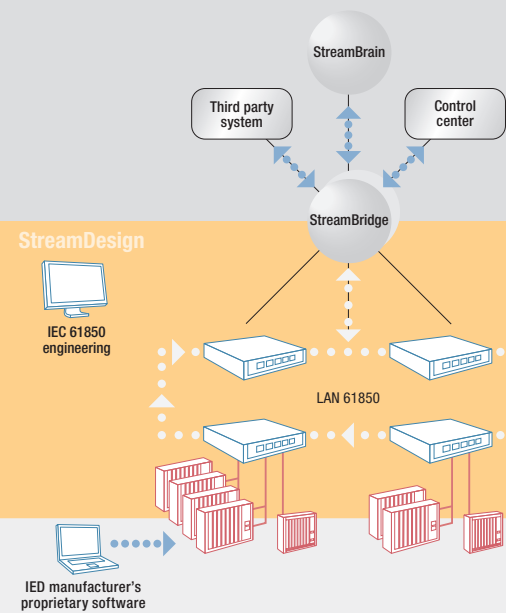

**Configurations, engineering...**

**Runtime**

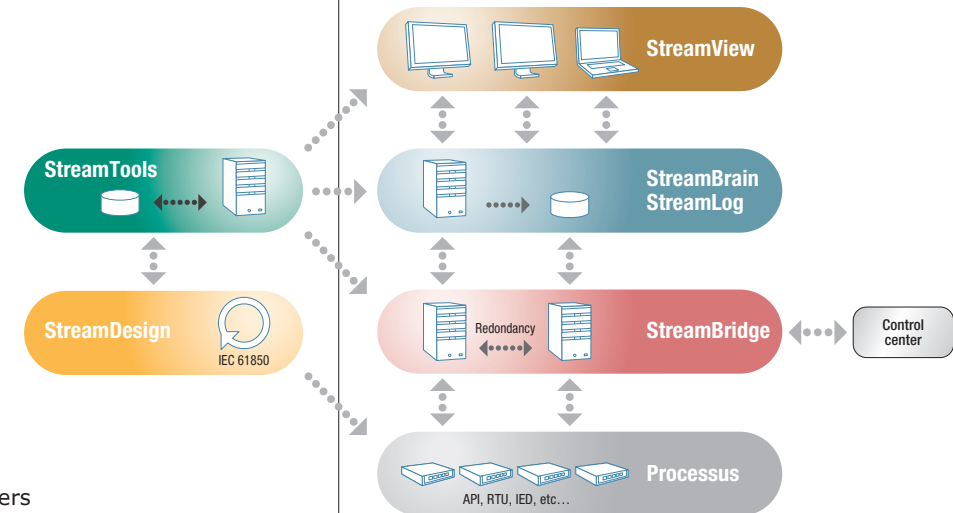

**Strengths**

- Control of the IEC 61850 station bus
- Integration of hardware from different suppliers of IEC 61850 compatible equipment
- Comprehensive documentation available at all times
- Facilitated maintenance and evolution for IEC 61850 applications
- Control of project implementation (lead times, costs, reliability)
- Control of performance of transmission and distribution infrastructures