



AUDITING TOOLS FOR IEC 61850

PS 2 , Q2.8

Rod Hughes (AU)

rgh@rodhughesconsulting.com

rodney.hughes@ghd.com

presented by Peter Bishop
CIGRE AU B5 Convenor

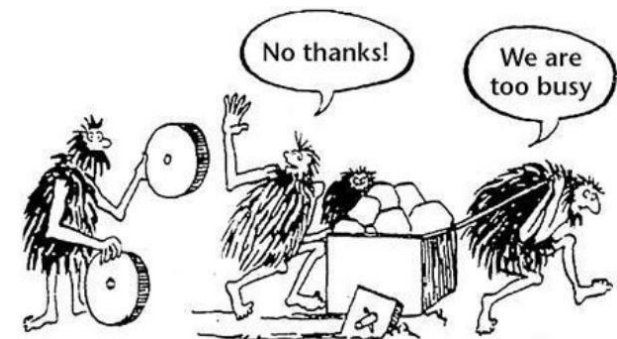

- Publish-Subscribe Excel matrix difficult to validate
- Need independent visualisation tool to interrogate and validate message configurations
- CIGRE SC B5 2017 Paper 102
QUALITY ASSURANCE OF GOOSE/SV
ENGINEERING CONFIGURATION IN THE
SCL FILES

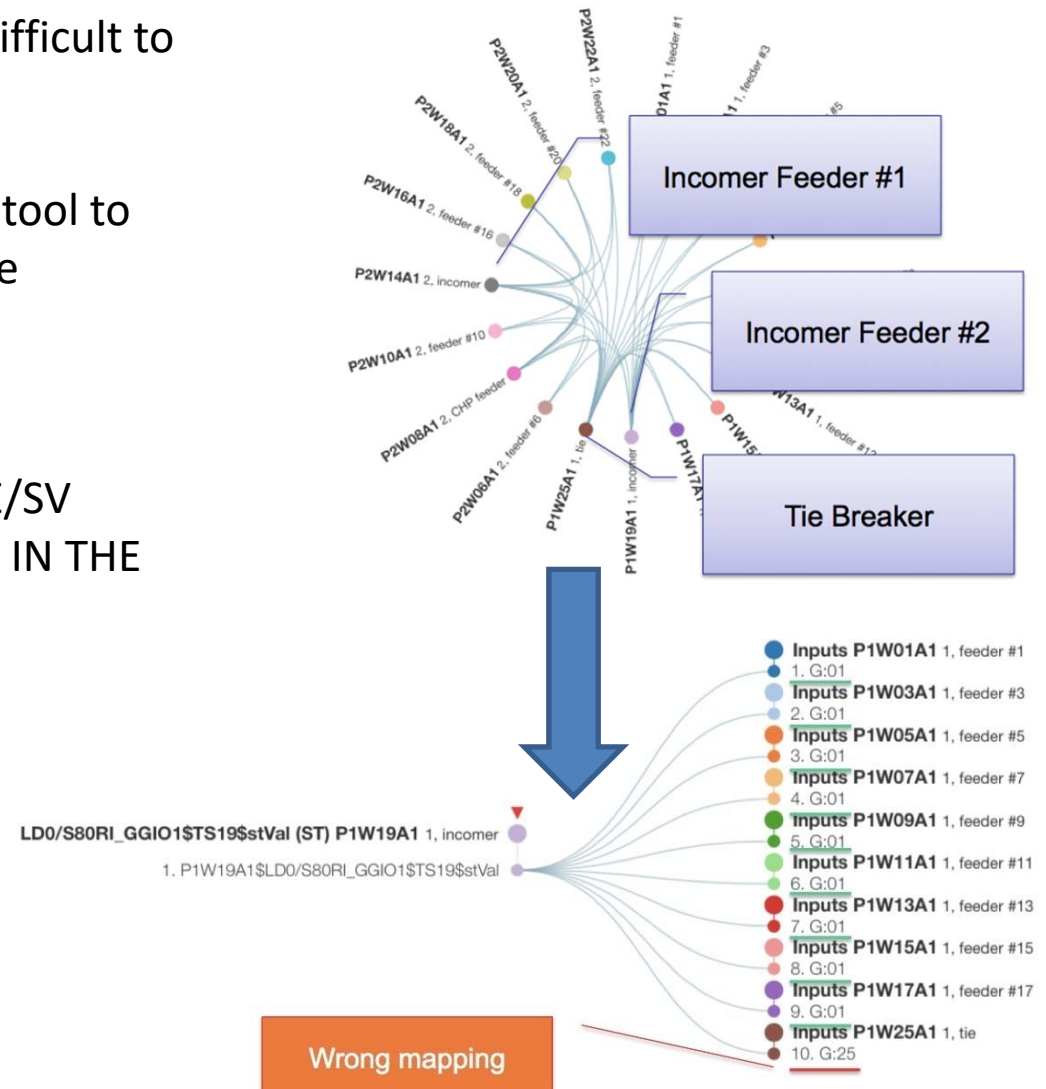

CIGRE SC B5 2017 Paper 103 QUALITY ASSURANCE OF GOOSE/SV ENGINEERING CONFIGURATION IN THE SCL FILES

SC B5 2018 CIGRE SESSION

- Hybrid operating and test environments

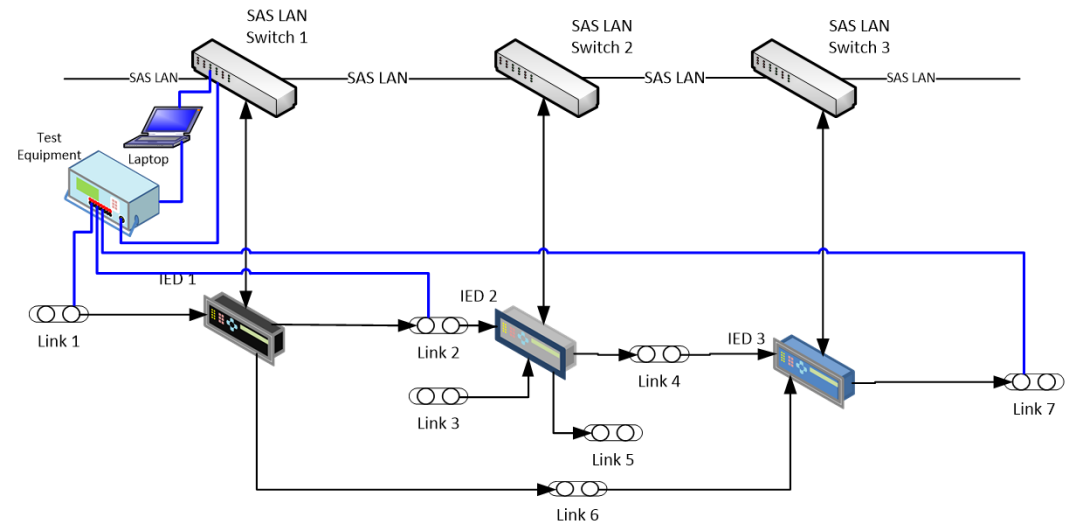

- Use GOOSE-Wire test interface unit to avoid throwing old conventional test sets in the bin!!

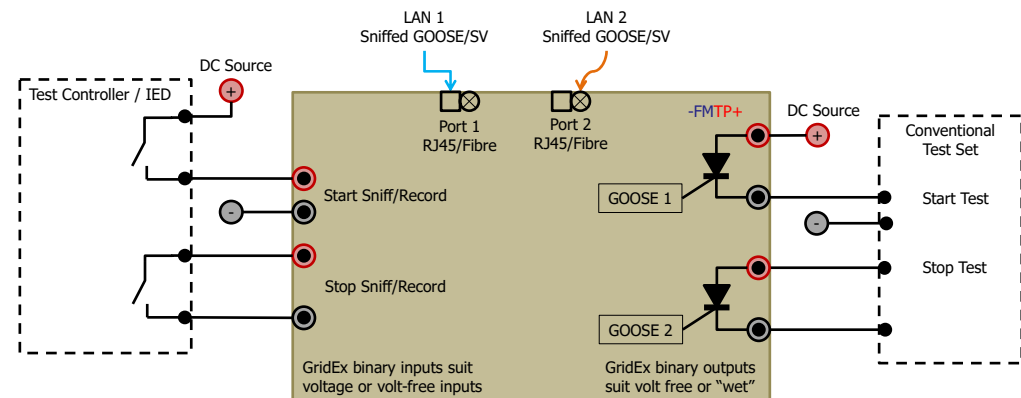

- Wireshark is a commonly used “visualisation” tool for LAN Messages
 - No inherent meaning of the dataset
 - No interpretation of the messages
- What is on/off
- Timing/sequence of events
- Waveform vector and harmonics display

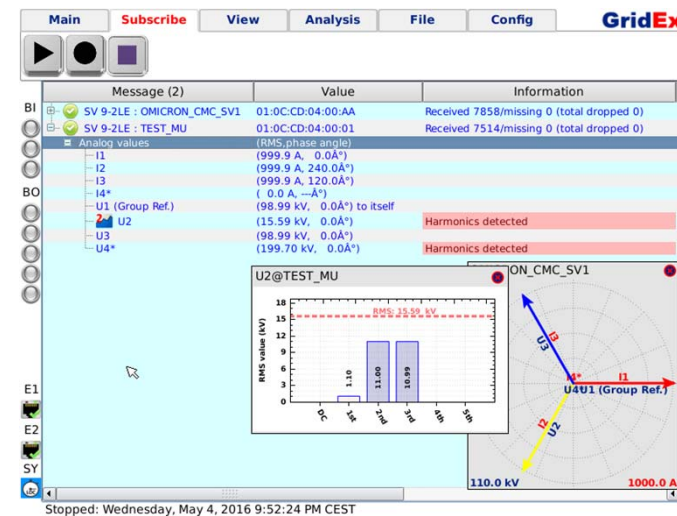
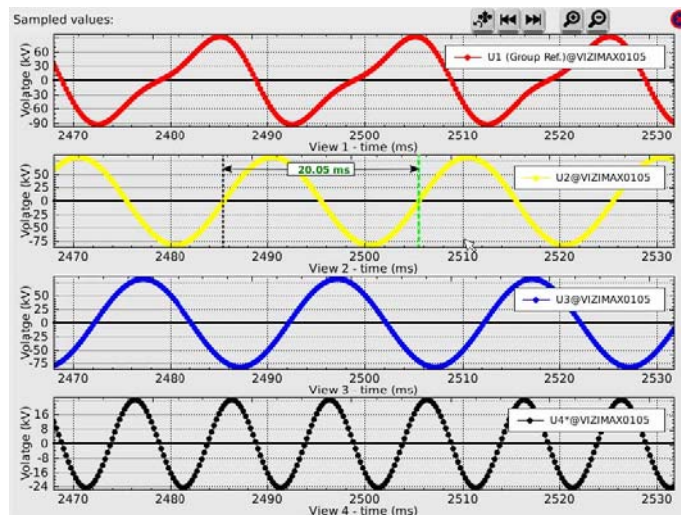
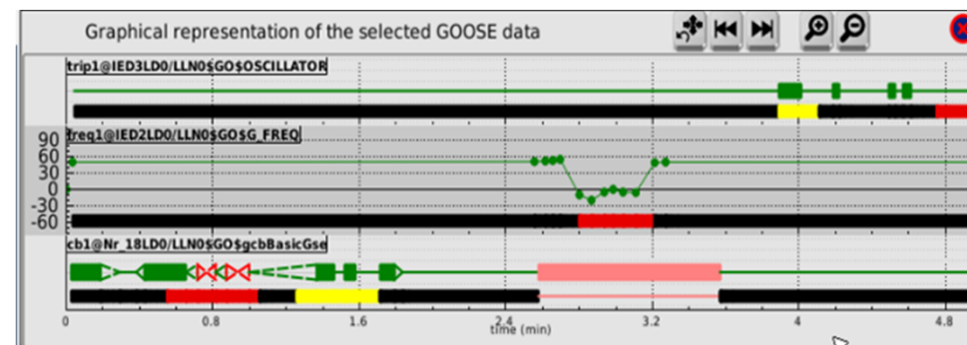
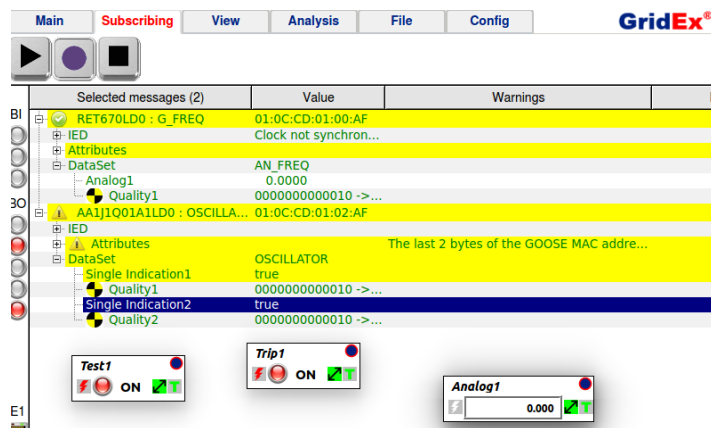



- Need independent visualisation tool to identify differences between as-operating configuration and SCL files
- Has the system been correctly configured according to the SCL files?
- Do you have true as-operating SCL files from the contractor?
- Has anything changed since last sniff?

Sniffed as operating today

Configuration as per SCL files

Compared in A (29)	Value	Compared in B (34)	Value
S7Sj64PROT : Control_DataSet1	01:0C:CD:01:00:00	S7Sj64PROT : Control_DataSet1	01:0C:CD:01:00:00
S7Sj64CTRL : Control_DataSet2	01:0C:CD:01:00:08	S7Sj64CTRL : Control_DataSet2	01:0C:CD:01:00:08
IED1LD0 : BRC	01:0C:CD:01:01:02	IED1LD0 : BRC	01:0C:CD:01:01:02
IED1LD0 : BRF	01:0C:CD:01:01:03	IED1LD0 : BRF	01:0C:CD:01:01:03
HU_PROLD0 : PROTECTA	01:0C:CD:01:00:00	HU_PROLD0 : PROTECTA	01:0C:CD:01:00:00
HU_PROLD0 : PROTECTB	01:0C:CD:01:00:01	HU_PROLD0 : PROTECTB	01:0C:CD:01:00:01
A130BL758CB1 : Intertrip	01:0C:CD:01:00:01	A130BL758CB1 : Intertrip	01:0C:CD:01:00:01
IED1LD0 : PSCH	01:0C:CD:01:01:08	IED1LD0 : PSCH	01:0C:CD:01:01:08
IED2LD0 : PHPIOC	01:0C:CD:01:02:05	IED2LD0 : PHPIOC	01:0C:CD:01:02:05
IED2LD0 : G_OVFREQ	01:0C:CD:01:02:02	IED2LD0 : G_OVFREQ	01:0C:CD:01:02:02
IED1LD0 : DPGGIO	01:0C:CD:01:01:07	IED1LD0 : DPGGIO	01:0C:CD:01:01:07
IED3LD0 : SPGGIO11T016	01:0C:CD:01:03:04	IED3LD0 : SPGGIO11T016	01:0C:CD:01:03:04
IED1LD0 : PDIS1	01:0C:CD:01:01:06	IED1LD0 : PDIS1	01:0C:CD:01:01:06
IED3LD0 : PDIS1	01:0C:CD:01:03:05	IED3LD0 : PDIS1	01:0C:CD:01:03:05
IED1LD0 : PLD	01:0C:CD:01:01:04	IED1LD0 : PLD	01:0C:CD:01:01:04
IED1LD0 : MMXU1	01:0C:CD:01:01:05	IED1LD0 : MMXU1	01:0C:CD:01:01:05
		FUTURE2PROT : Control_DataSet1	01:0C:CD:01:0F:00
		FUTURE1LD0 : BRC	01:0C:CD:01:0F:01
		FUTURE1LD0 : BRF	01:0C:CD:01:0F:02
		FUTURE1LD0 : MMXU1	01:0C:CD:01:0F:03

As operating has missing GOOSE

Sniffed as operating 12 months ago

Sniffed as operating today

Devices or configurations changed

Compared in A (29)	Value	Compared in B (29)	Value
IED3LD0 : OSCILLATOR	01:0C:CD:01:03:01	IED3LD0 : OSCILLATOR	01:0C:CD:01:03:01
IED2LD0 : qcbTRIP	01:0C:CD:01:02:03	IED2LD0 : qcbTRIP	01:0C:CD:01:02:03
IED3LD0 : SPGTRIP	01:0C:CD:01:03:02	IED3LD0 : SPGTRIP	01:0C:CD:01:03:02
A130BL758CB1 : Intertrip	01:0C:CD:01:00:00	A130BL758CB1 : Intertrip	01:0C:CD:01:00:00
P139System : qcb02	01:0C:CD:01:00:03	P139System : qcb02	01:0C:CD:01:00:03
S7Sj64CTRL : Control_DataSet1	01:0C:CD:01:00:08	S7Sj64CTRL : Control_DataSet1	01:0C:CD:01:00:08
S7Sj64CTRL : Control_DataSet2	01:0C:CD:01:00:1C	S7Sj64CTRL : Control_DataSet2	01:0C:CD:01:00:1C
IED2LD0 : PHPIOC	01:0C:CD:01:02:05	IED2LD0 : PHPIOC	01:0C:CD:01:02:05
IED1LD0 : MSQI	01:0C:CD:01:01:06	IED1LD0 : MSQI	01:0C:CD:01:01:06
IED3LD0 : PDIS1	01:0C:CD:01:03:05	IED3LD0 : PDIS1	01:0C:CD:01:03:05
IED1LD0 : PLD	01:0C:CD:01:01:04	IED1LD0 : PLD	01:0C:CD:01:01:04
IED1LD0 : PSCH	01:0C:CD:01:01:08	IED1LD0 : PSCH	01:0C:CD:01:01:08
IED1LD0 : MMXU1	01:0C:CD:01:01:05	IED1LD0 : MMXU1	01:0C:CD:01:01:05
AA1735kVL1A1LD0 : ABB...	01:0C:CD:01:00:00	AA1735kVL1A1LD0 : ABB...	01:0C:CD:01:00:00
AA1735kVL1A1LD0 : ABB...	01:0C:CD:01:00:05	AA1735kVL1A1LD0 : ABB...	01:0C:CD:01:00:05

Devices or configurations changed